



TRANE®

Upflow/Horizontal Condensing, Gas-Fired Furnace

XB 90

TUC1B040A9241A, TUC1B060A9361A
TUC1B080A9421A, TUC1C100A9481A
TUC1D100A9601A, TUC1D120A9601A
Single-Stage Fan Assisted
Combustion System

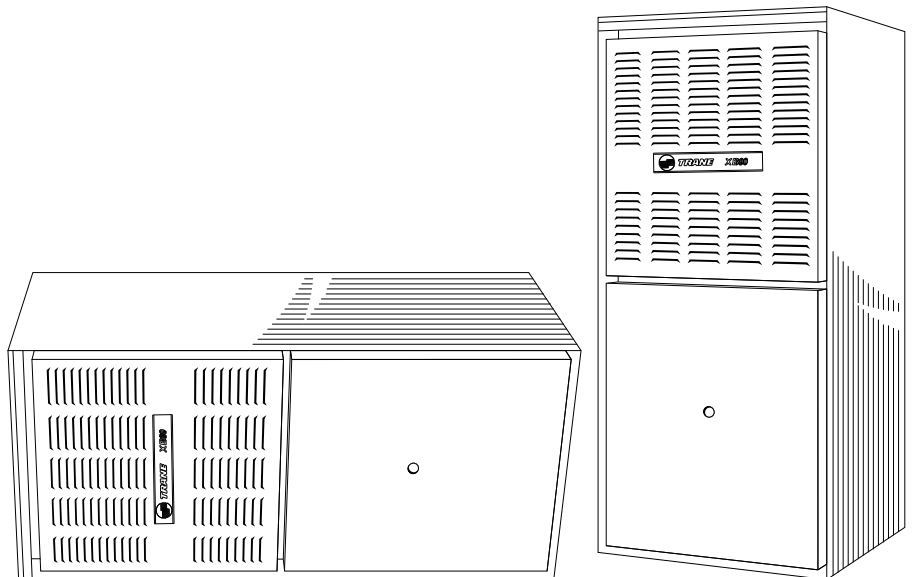

PUB. NO. 22-1669-08



General Features

NATURAL GAS MODELS

Central Heating furnace designs are certified by the American Gas Association for both natural and L.P. gas. Limit setting and rating data were established and approved under standard rating conditions using American National Standards Institute standards.

SAFE OPERATION

The Integrated System Control has solid state devices, which continuously monitor for presence of flame, when the system is in the heating mode of operation. Dual solenoid combination gas valve and regulator provide extra safety.

QUICK HEATING

Durable, cycle tested, heavy gauge **aluminized steel heat exchanger** quickly transfers heat to provide warm conditioned air to the structure. **Low energy power vent blower**, to increase efficiency and provide a positive discharge of gas fumes to the outside.

BURNERS

Multiport Inshot burners will give years of quiet and efficient service. All models can be converted to **L.P. gas** without changing burners.

INTEGRATED SYSTEM CONTROL

Exclusively designed operational program provides total control of furnace limit sensors, blowers, gas valve, flame control and includes self diagnostics for ease of service. Also contains connection points for E.A.C./humidifier.

AIR DELIVERY

The variable speed, direct drive blower motor, has sufficient airflow for most heating and cooling requirements, will switch from heating to cooling speeds on demand from room thermostat. The blower door safety switch will prevent or terminate furnace operation when the blower door is removed.

STYLING

Heavy gauge steel and “wrap-around” cabinet construction is used in the cabinet with baked-on enamel finish for strength and beauty. The heat exchanger section of the cabinet is completely lined with foil faced fiberglass insulation. This results in quiet and efficient operation due to the excellent acoustical and insulating qualities of fiberglass. Built-in bottom pan and alternate bottom, left or right side return air connection provision.

FEATURES AND GENERAL OPERATION

The XB 90 High Efficiency Gas Furnaces employ a Hot Surface Ignition system, which eliminates the waste of a constant burning pilot. The integrated system control lights the main burners upon a demand for heat from the room thermostat. Complete front service access.

- a. Low energy power venter
- b. Vent proving pressure switch.

Contents

Feature Summary	2
Features and Benefits	4
Standard Equipment	
Optional Equipment	
General Data	5
TUC1B040A9241A	
TUC1B060A9361A	
TUC1B080A9421A	
TUC1C100A9481A	
TUC1D100A9601A	
TUCAD120A9601A	
Performance Data	7
Electrical Data	8
Field Wiring	10
Dimensions	11



Features and Benefits

XB 90 STANDARD EQUIPMENT

- Power supply 115/1/60
- Upflow convertible to horizontal left
- **Type 29-4C™** stainless steel secondary heat exchanger
- Direct drive, 4-speed motor
- Silicon Carbide hot surface igniter with adaptive heat up
- Accessory hook-up capability- Hum & EAC
- Quiet induced draft blower
- Blower door safety switch
- Dual solenoid combination gas valve & regulator
- PVC venting - 1 Pipe
- Left/right gas connection
- Integrated solid state control with self-diagnostics
- Selectable cooling fan off delay eliminates need for BAY24X045 time delay relay
- 24 volt fuse
- Manual reset burner box limit
- **Optional extended warranties**

XB 90 OPTIONAL EQUIPMENT

Thermostat, Mechanical Heating Only Without Fan Switch	BAYSTAT388 []
Thermostat, Electronic Programmable 1-Stage Heating/1-Stage Cooling	TAYSTAT300C []
Propane Conversion Kit	BAYLPKT210A []
Electronic Air Filter, "Perfect Fit" Super Efficiency (17-1/2" Wide Gas Furnace)	TFE175A9FR0 []
Electronic Air Filter, "Perfect Fit" Super Efficiency (21" Wide Gas Furnace)	TFE210A9FR0 []
Electronic Air Filter, "Perfect Fit" Super Efficiency (24-1/2" Wide Gas Furnace)	TFE245A9FR0 []
Electronic Air Filter, "Perfect Fit" High Efficiency (17-1/2" Wide Gas Furnace)	TFM175A9FR0 []
Electronic Air Filter, "Perfect Fit" High Efficiency (21" Wide Gas Furnace)	TFM210A9FR0 []
Electronic Air Filter, "Perfect Fit" High Efficiency (24-1/2" Wide Gas Furnace)	TFM245A9FR0 []
Electronic Air Filter, "Perfect Fit" Standard Efficiency (17-1/2" Wide Gas Furnace)	TFP175A9FR0 []
Electronic Air Filter, "Perfect Fit" Standard Efficiency (21" Wide Gas Furnace)	TFP210A9FR0 []
Electronic Air Filter, "Perfect Fit" Standard Efficiency (24-1/2" Wide Gas Furnace)	TFP245A9FR0 []
Coil Enclosure (17-1/2" Wide Cabinets)	BAYCLE17A1722A []
Coil Enclosure (21" Wide Cabinets)	BAYCLE21A2130A []
Coil Enclosure (24-1/2" Wide Cabinets)	BAYCLE24A2430A []
Side Filter Rack	BAYFLTR200 []
High Altitude Switch	BAYHALT225 []
High Altitude Switch	BAYHALT226 []
High Altitude Switch	BAYHALT228 []
High Altitude Switch	BAYHALT240 []
Filter Kit Horizontal conversion TUC01B40,060,080C	BAYFLTR203 []
Filter Kit Horizontal conversion TUC1C100X948B	BAYFLTR204 []
Filter Kit Horizontal conversion TUC1D100C960, TUC1D120C	BAYFLTR205 []
Twining Kit	BAYTWIN400A []
Wall Mount Flange-3"	BAY96X147 []
Wall Mount Flange-2"	BAY96X148 []
Horizontal Vent Cap (Noryl)	BAY96X146 []



General Data

PRODUCT SPECIFICATIONS ①

MODEL	TUC1B040A9241A	TUC1B060A9361A	TUC1B080A9421A
TYPE	Upflow / Horizontal	Upflow / Horizontal	Upflow / Horizontal
RATINGS ②			
Input BTUH	40,000	60,000	80,000
Capacity BTUH (ICS) ③	37,000	56,000	74,000
AFUE	92.0	92.0	92.0
Temp. rise (Min.-Max.) °F.	30 - 60	30 - 60	35 - 65
BLOWER DRIVE	DIRECT	DIRECT	DIRECT
Diameter - Width (In.)	9 x 7	10 x 7	10 x 8
No. Used	1	1	1
Speeds (No.)	4	4	4
CFM vs. in. w.g.	See Fan Performance Table	See Fan Performance Table	See Fan Performance Table
Motor HP	1/5	1/3	1/3
R.P.M.	1075	1075	1075
Volts / Ph / Hz	115/1/60	115/1/60	115/1/60
COMBUSTION FAN - Type	Centrifugal	Centrifugal	Centrifugal
Drive - No. Speeds	Direct - 1	Direct - 1	Direct - 1
Motor HP - RPM	1/55 - 3000	1/55 - 3000	1/25 - 3200
Volts / Ph / Hz	115/1/60	115/1/60	115/1/60
FLA	1.0	1.0	1.35
FILTER — Furnished?	No	No	No
Type Recommended	High Velocity	High Velocity	High Velocity
Hi Vel. (No.-Size-Thk.)	1 - 17x25 - 1in.	1 - 17x25 - 1in.	1 - 17x25 - 1in.
VENT — Size (in.)	2 Round	2 Round	2 Round
HEAT EXCHANGER			
Type-Fired	Aluminized Steel - Type I	Aluminized Steel - Type I	Aluminized Steel - Type I
-Unfired			
Gauge (Fired)	20	20	20
ORIFICES — Main			
Nat. Gas Qty. — Drill Size	2 — 45	3 — 45	4 — 45
L.P. Gas Qty. — Drill Size	2 — 56	3 — 56	4 — 56
GAS VALVE	Redundant - Single Stage	Redundant - Single Stage	Redundant - Single Stage
PILOT SAFETY DEVICE			
Type	Hot Surface Ignition	Hot Surface Ignition	Hot Surface Ignition
BURNERS — Type	Multiport Inshot	Multiport Inshot	Multiport Inshot
Number	2	3	4
POWER CONN. — V / Ph / Hz ④	115/1/60	115/1/60	115/1/60
Ampacity (In Amps)	4.7	8.3	9.4
Max Overcurrent Protection (Amps)	15	15	15
PIPE CONN. SIZE (IN.)	1/2	1/2	1/2
DIMENSIONS	H x W x D	H x W x D	H x W x D
Crated (In.)	41-3/4 x 19-1/2 x 30-1/2	41-3/4 x 19-1/2 x 30-1/2	41-3/4 x 19-1/2 x 30-1/2
WEIGHT			
Shipping (Lbs.) / Net (Lbs)	139 / 129	150 / 140	158 / 148

① Central Furnace heating designs are certified by AGA and CSA.

② For U.S. applications, above input ratings (BTUH) are up to 2,000 feet, derate 4% per 1,000 feet for elevations above 2,000 feet above sea level. For Canadian applications, above input ratings (BTUH) are up to 4,500 feet, derate 4% per 1,000 feet for elevations above 4,500 feet above sea level.

③ Based on U.S. government standard tests.

④ The above wiring specifications are in accordance with National Electrical Code; however, installations must comply with local codes.



General Data

PRODUCT SPECIFICATIONS ①

MODEL	TUC1C100A9481A	TUC1D100A9601A	TUC1D120A9601A
TYPE	Upflow / Horizontal	Upflow / Horizontal	Upflow / Horizontal
RATINGS ②			
Input BTUH	100,000	100,000	120,000
Capacity BTUH (ICS) ③	94,000	93,000	113,000
AFUE	92.0	92.0	92.0
Temp. rise (Min.-Max.) °F.	35 - 65	35 - 65	40 - 70
BLOWER DRIVE	DIRECT	DIRECT	DIRECT
Diameter - Width (In.)	10 x 10	11 x 10	11 x 10
No. Used	1	1	1
Speeds (No.)	4	4	4
CFM vs. in. w.g.	See Fan Performance Table	See Fan Performance Table	See Fan Performance Table
Motor HP	1/2	3/4	3/4
R.P.M.	1075	1100	1100
Volts / Ph / Hz	115/1/60	115/1/60	115/1/60
COMBUSTION FAN - Type	Centrifugal	Centrifugal	Centrifugal
Drive - No. Speeds	Direct - 1	Direct - 1	Direct - 1
Motor HP - RPM	1/20 - 3450	1/20 - 3450	1/20 - 3450
Volts / Ph / Hz	115/1/60	115/1/60	115/1/60
FLA	0.71	0.71	0.71
FILTER — Furnished?	No	No	No
Type Recommended	High Velocity	High Velocity	High Velocity
Hi Vel. (No.-Size-Thk.)	1 - 20x25 - 1in.	1 - 24x25 - 1in.	1 - 24x25 - 1in.
VENT — Size (in.)	2 Round	2 Round	3 Round
HEAT EXCHANGER			
Type-Fired	Aluminized Steel - Type I	Aluminized Steel - Type I	Aluminized Steel - Type I
-Unfired			
Gauge (Fired)	20	20	20
ORIFICES — Main			
Nat. Gas. Qty. — Drill Size	5 — 45	5 — 45	6 — 45
L.P. Gas Qty. — Drill Size	5 — 56	5 — 56	6 — 56
GAS VALVE	Redundant - Single Stage	Redundant - Single Stage	Redundant - Single Stage
PILOT SAFETY DEVICE			
Type	Hot Surface Ignition	Hot Surface Ignition	Hot Surface Ignition
BURNERS — Type	Multiport Inshot	Multiport Inshot	Multiport Inshot
Number	5	5	6
POWER CONN. — V / Ph / Hz ④	115/1/60	115/1/60	115/1/60
Ampacity (In Amps)	12.5	12.9	12.9
Max Overcurrent Protection (Amps)	15	15	15
PIPE CONN. SIZE (IN.)	1/2	1/2	1/2
DIMENSIONS	H x W x D	H x W x D	H x W x D
Crated (In.)	41-3/4 x 23 x 30-1/2	41-3/4 x 26-1/2 x 30-1/2	41-3/4 x 26-1/2 x 30-1/2
WEIGHT			
Shipping (Lbs.) / Net (Lbs)	171 / 160	197 / 185	205 / 193

① Central Furnace heating designs are certified by AGA and CSA.

② For U.S. applications, above input ratings (BTUH) are up to 2,000 feet, derate 4% per 1,000 feet for elevations above 2,000 feet above sea level. For Canadian applications, above input ratings (BTUH) are up to 4,500 feet, derate 4% per 1,000 feet for elevations above 4,500 feet above sea level.

③ Based on U.S. government standard tests.

④ The above wiring specifications are in accordance with National Electrical Code; however, installations must comply with local codes.



Performance Data

FURNACE AIRFLOW (CFM) VS. EXTERNAL STATIC PRESSURE (INS. w.g.)										
MODEL	SPEED TAP	0.10	0.20	0.30	0.40	0.50	0.60	0.70	0.80	0.90
TUC1B040A9241A	4 - HIGH - Black	1043	992	930	885	812	740	647	518	157
	3 - MED.-HIGH - Blue	940	895	841	791	726	650	559	420	90
	2 - MED.-LOW - Yellow	837	798	752	705	649	560	438	305	79
	1 - LOW - Red	729	694	657	600	545	478	376	220	78
TUC1B060A9361A	4 - HIGH - Black	1394	1359	1314	1260	1196	1122	1038	945	853
	3 - MED.-HIGH - Blue	1250	1232	1202	1160	1106	1040	962	873	771
	2 - MED.-LOW - Yellow	1102	1092	1069	1034	986	925	852	766	668
	1 - LOW - Red	957	944	922	891	853	806	750	686	614
TUC1B080A9421A	4 - HIGH - Black	1748	1683	1615	1544	1470	1393	1314	1232	1147
	3 - MED.-HIGH - Blue	1375	1367	1347	1314	1268	1210	1139	1056	960
	2 - MED.-LOW - Yellow	1178	1167	1147	1119	1082	1036	982	919	847
	1 - LOW - Red	859	863	856	839	811	772	723	663	592
TUC1C100A9481A	4 - HIGH - Black	2054	1980	1906	1826	1746	1649	1551	1428	1305
	3 - MED.-HIGH - Blue	1932	1875	1818	1746	1673	1577	1481	1371	1260
	2 - MED.-LOW - Yellow	1762	1720	1677	1615	1552	1463	1373	1266	1158
	1 - LOW - Red	1558	1546	1533	1477	1421	1350	1278	1175	1071
TUC1D100A9601A	4 - HIGH - Black	2411	2358	2304	2235	2165	2083	2001	1915	1828
	3 - MED.-HIGH - Blue	2108	2083	2058	2007	1956	1893	1829	1754	1679
	2 - MED.-LOW - Yellow	1772	1759	1745	1723	1700	1657	1613	1544	1475
	1 - LOW - Red	1480	1477	1474	1458	1441	1414	1386	1327	1268
TUC1D120A9601A	4 - HIGH - Black	2454	2406	2358	2310	2261	2184	2106	2017	1928
	3 - MED.-HIGH - Blue	2105	2092	2078	2045	2012	1950	1887	1826	1765
	2 - MED.-LOW - Yellow	1747	1742	1736	1720	1703	1677	1651	1593	1535
	1 - LOW - Red	1445	1447	149	1440	1430	1400	1369	1325	1280

CFM VS. TEMPERATURE RISE																	
MODEL	Cubic Feet Per Minute (CFM)																
	600	700	800	900	1000	1100	1200	1300	1400	1500	1600	1700	1800	1900	2000	2100	2200
TUC1B040A9241A	56	48	42	37	33												
TUC1B060A9361A				56	50	45	42	39	36								
TUC1B080A9421A						61	56	51	48	44	42						
TUC1C100A9481A								64	60	56	52	49	46	44	42		
TUC1D100A9601A								64	60	56	52	49	46	44	42	40	38
TUC1D120A9601A											63	59	56	53	50	48	46

Electrical Data

SCHEMATIC DIAGRAMS FOR GAS FURNACES

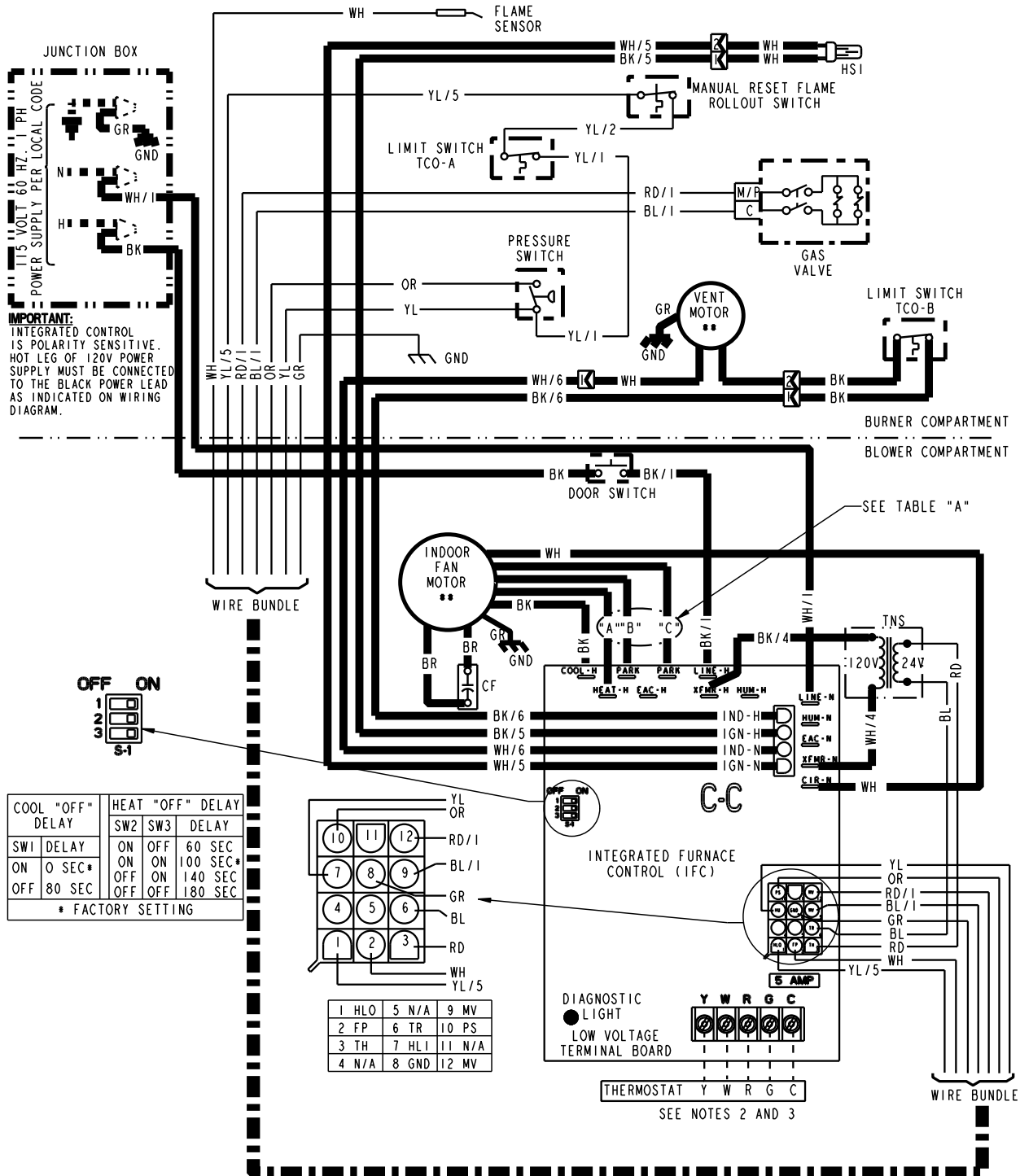

Electrical Data

SCHEMATIC DIAGRAMS FOR GAS FURNACES

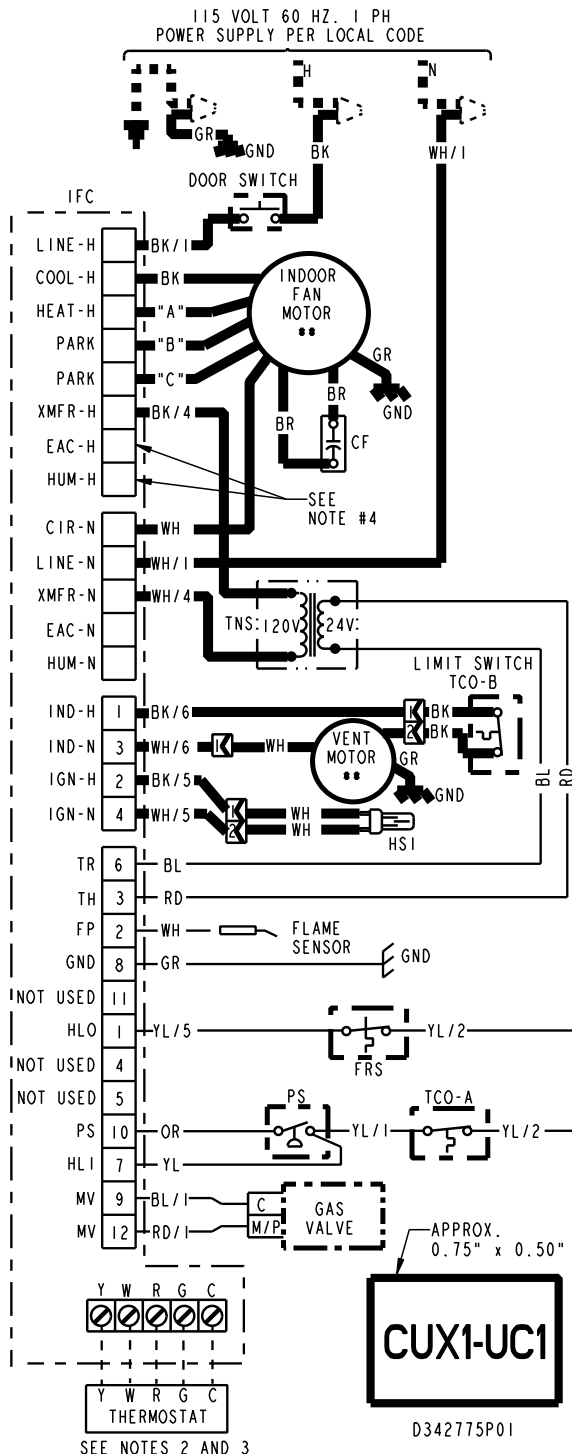

TABLE "A"			
SPEED TAPS FOR I.D. FAN MOTOR			
MODEL	HEAT "A"	PARK "B"	PARK "C"
CUX1B040A9241A* #UC1B040A9241A*	YL	RD	BL
CUX1B060A9361A* #UC1B060A9361A*	BL	RD	YL
CUX1B080A9421A* #UC1B080A9421A*	BL	RD	YL
CUX1C100A9481A* #UC1C100A9481A*	BL	RD	YL
CUX1D100A9601A* #UC1D100A9601A*	YL	RD	BL
CUX1D120A9601A* #UC1D120A9601A*	BL	RD	YL

RD = LOW BL = MED. HIGH
YL = MED. LOW BK = HIGH
- MAY BE "T" or "A"
* - MAY BE A THROUGH Z

WARNING

HAZARDOUS VOLTAGE:
DISCONNECT ALL ELECTRICAL POWER INCLUDING REMOTE DISCONNECTS BEFORE SERVICING.
FAILURE TO DISCONNECT POWER BEFORE SERVICING CAN CAUSE SEVERE PERSONAL INJURY OR DEATH.

CAUTION

USE COPPER CONDUCTORS ONLY!
UNIT TERMINALS ARE NOT DESIGNED TO ACCEPT OTHER TYPES OF CONDUCTORS.
FAILURE TO DO SO MAY CAUSE DAMAGE TO THE EQUIPMENT.

INTEGRATED FURNACE CONTROL
REPLACE WITH PART CNT02891 OR CNT 02183 OR EQUIVALENT
INPUT: 25 VAC, 60 HZ.
XFMR SEC. CURRENT: 450 MA.
MV OUTPUT: 1.5 A @ 24 VAC
IND OUTPUT: 2.2 FLA, 3.5 LRA @ 120 VAC
CIRC. BLOWER OUTPUT: 14.5 FLA, 26 LRA @ 120 VAC
HUMIDIFIER & AIR CLEANER
MAX. LOAD: 1.0 A @ 120 VAC
IGNITER OUTPUT: 6.0 A @ 120 VAC

DIAGNOSTIC CODES

FLASHING SLOW: NORMAL - NO CALL FOR HEAT
FLASHING FAST: NORMAL - CALL FOR HEAT
CONTINUOUS ON: REPLACE IFC
CONTINUOUS OFF: CHECK POWER
2 FLASHES: EXTERNAL LOCKOUT (RETRIES OR RECYCLES EXCEEDED)
3 FLASHES: PRESSURE SWITCH ERROR
4 FLASHES: OPEN LIMIT DEVICE
5 FLASHES: FLAME SENSED WHEN NO FLAME SHOULD BE PRESENT
6 FLASHES: 115 VAC POWER REVERSED POLARITY OR POOR GROUNDING
7 FLASHES: GAS VALVE CIRCUIT ERROR
8 FLASHES: LOW FLAME SENSE SIGNAL

	TCO THERMAL CUT OUT		LINE } FACTORY 24 V } WIRING	<table border="1"> <tr> <td>BK</td><td>BLACK</td> <td>GR</td><td>GREEN</td> </tr> <tr> <td>WH</td><td>WHITE</td> <td>BR</td><td>BROWN</td> </tr> <tr> <td>YL</td><td>YELLOW</td> <td>RD</td><td>RED</td> </tr> <tr> <td>OR</td><td>ORANGE</td> <td>BL</td><td>BLUE</td> </tr> </table>	BK	BLACK	GR	GREEN	WH	WHITE	BR	BROWN	YL	YELLOW	RD	RED	OR	ORANGE	BL	BLUE								
BK	BLACK	GR	GREEN																									
WH	WHITE	BR	BROWN																									
YL	YELLOW	RD	RED																									
OR	ORANGE	BL	BLUE																									
	PS PRESSURE SWITCH		LINE } FIELD 24 V } WIRING																									
	FRS FLAME ROLLOUT SWITCH		•• INTERNAL THERMAL PROTECTION	<table border="1"> <tr> <td>L</td><td>LINE</td> <td>TH</td><td>24 VAC (HOT)</td> </tr> <tr> <td>N</td><td>NEUTRAL</td> <td>TR</td><td>24 VAC (COMMON)</td> </tr> <tr> <td>GND</td><td>GROUND</td> <td>MV</td><td>MAIN GAS VALVE</td> </tr> <tr> <td>B/C</td><td>COMMON</td> <td>TNS</td><td>TRANSFORMER</td> </tr> <tr> <td>HLO</td><td>HIGH LIMIT OUTPUT</td> <td></td><td></td> </tr> <tr> <td>HLI</td><td>HIGH LIMIT INPUT</td> <td></td><td></td> </tr> </table>	L	LINE	TH	24 VAC (HOT)	N	NEUTRAL	TR	24 VAC (COMMON)	GND	GROUND	MV	MAIN GAS VALVE	B/C	COMMON	TNS	TRANSFORMER	HLO	HIGH LIMIT OUTPUT			HLI	HIGH LIMIT INPUT		
L	LINE	TH	24 VAC (HOT)																									
N	NEUTRAL	TR	24 VAC (COMMON)																									
GND	GROUND	MV	MAIN GAS VALVE																									
B/C	COMMON	TNS	TRANSFORMER																									
HLO	HIGH LIMIT OUTPUT																											
HLI	HIGH LIMIT INPUT																											
	FP FLAME SENSOR		CF CAPACITOR																									
	CHASSIS GROUND		COIL																									
	HSI HOT SURFACE IGNITER																											
	DOOR SWITCH																											

WIRE COLOR
BK/1 NUMBER ID (IF ANY)

NOTES:

- IF ANY OF THE ORIGINAL WIRING AS SUPPLIED WITH THIS FURNACE MUST BE REPLACED, IT MUST BE WITH WIRE HAVING A TEMPERATURE RATING OF AT LEAST 105 C.
- THERMOSTAT HEAT ANTICIPATOR SETTING: .38 AMPS
- FOR PROPER OPERATION OF COOLING SPEED, "Y" TERMINAL MUST BE CONNECTED TO THE ROOM THERMOSTAT.
- THESE TERMINALS PROVIDE 120V POWER CONNECTIONS FOR ELECTRONIC AIR CLEANER (EAC) AND HUMIDIFIER (HUM). MAX. LOAD: 1.0 AMPS EACH.

Field Wiring

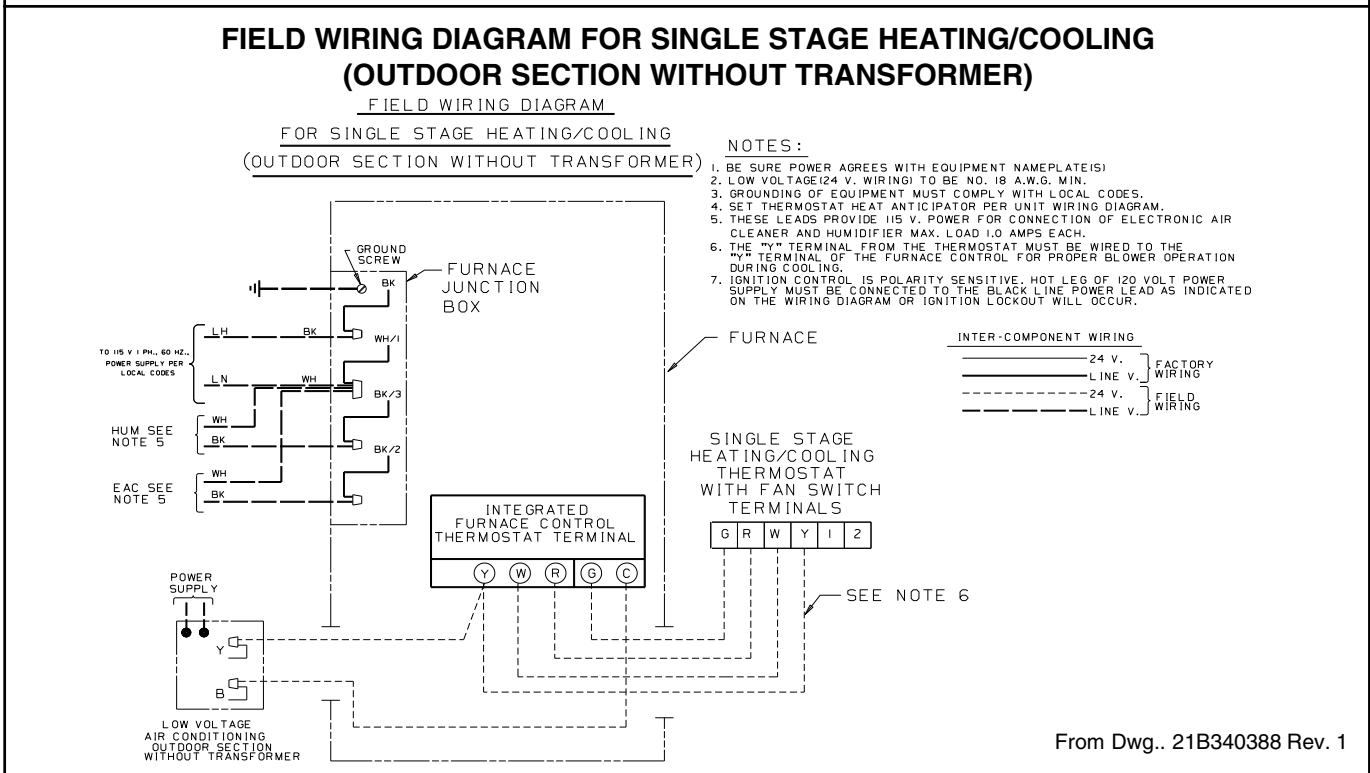
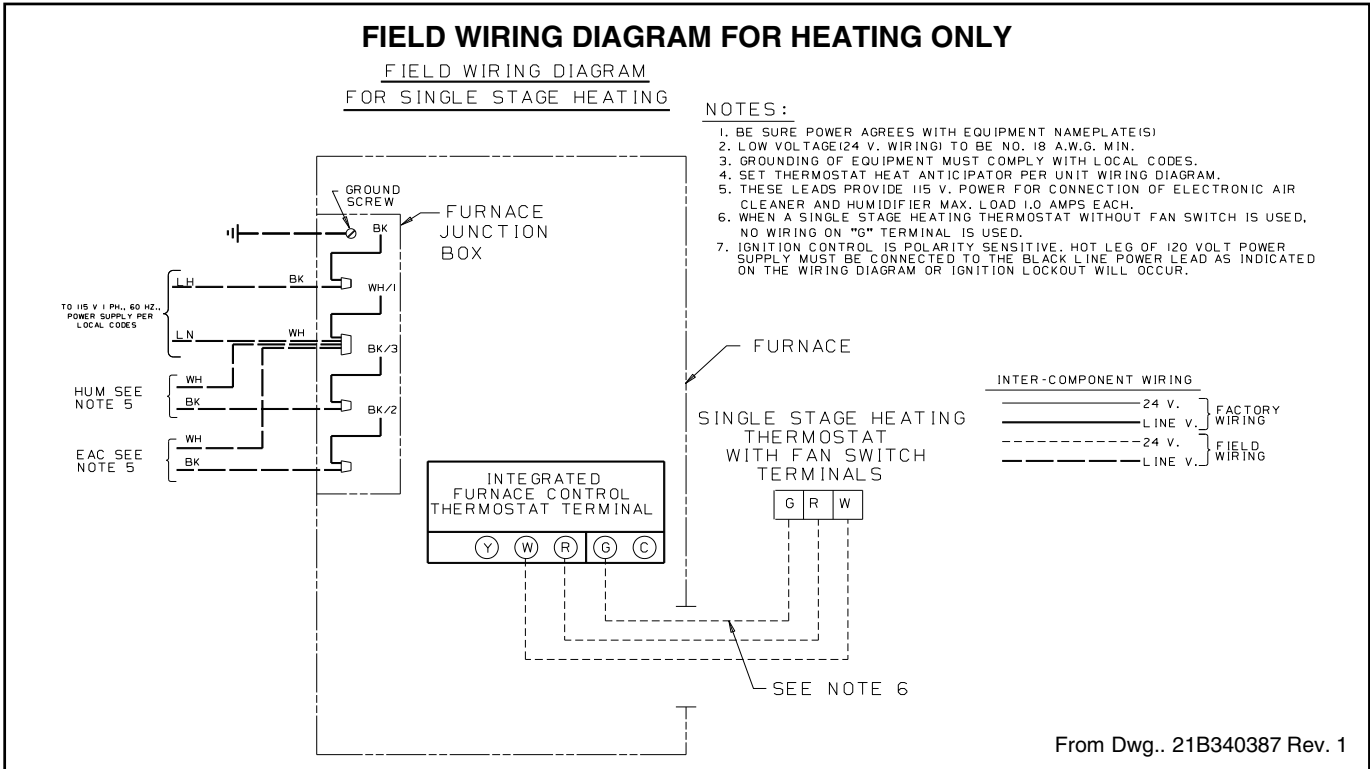

Dimensions

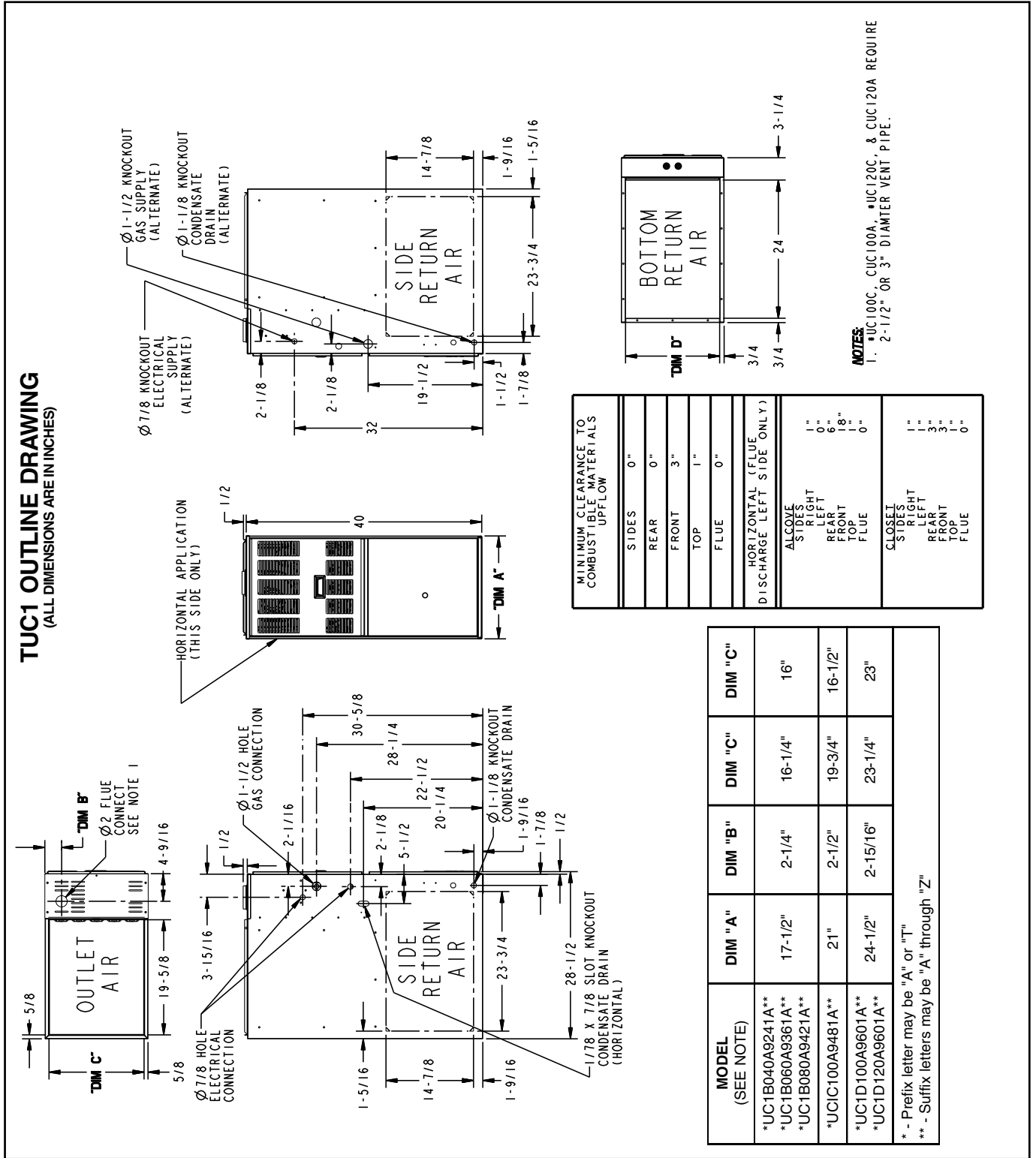

MINIMUM CLEARANCE TO COMBUSTIBLE MATERIALS UPFLOW	
SIDES	0"
REAR	0"
FRONT	3"
TOP	1"
FLUE	0"
HORIZONTAL (FLUE DISCHARGE LEFT SIDE ONLY)	
ALCOVE SIDES	
RIGHT	1"
LEFT	6"
FRONT	18"
TOP	0"
FLUE	0"
CLOSEST SIDES	
RIGHT	1"
LEFT	1"
FRONT	3"
TOP	1"
FLUE	0"

MODEL (SEE NOTE)	DIM "A"	DIM "B"	DIM "C"	DIM "C"
*UC1B040A9241A**	17-1/2"	2-1/4"	16-1/4"	16"
*UC1B060A9361A**				
*UC1B080A9421A**				
*UC1C100A9481A**	21"	2-1/2"	19-3/4"	16-1/2"
*UC1D100A9601A**				
*UC1D120A9601A**	24-1/2"	2-15/16"	23-1/4"	23"

* - Prefix letter may be "A" or "T"
 ** - Suffix letters may be "A" through "Z"

NOTES:
 1. *UC100C, CUC100A, *UC120C, & CUC120A REQUIRE 2-1/2" OR 3" DIAMETER VENT PIPE.



Trane
6200 Troup Highway
Tyler, TX 75707

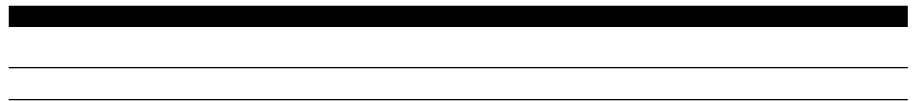

Since Trane has a policy of continuous product and product data improvement, it reserves the right to change design and specifications without notice.